

# DS3000 AUDIBLE PEDESTRIAN SIGNAL INSTALLATION GUIDE

**General Notes:** Adjustment of the APS is best accomplished with two people. One to adjust the APS, the second to listen to the relative levels as required herein. If the Push Button Locator Speaker is not used (ie. Overhead Beacon Speaker only) please directly to Step 8. "Testing the Overhead Beacon Sound Level".

## 7. Testing the Push Button Locator Sound Level

### Normal Operation:

The push button locator "click" sound should be detectable at 2 to 4 meters (6 to 12 feet) from the push button (regardless of ambient sound level). Please note that the sound level will automatically adjust with subtle changes in ambient sound and may not be obvious to the listener. **The default settings from the factory are for a standard 4-lane intersection. These adjustments can be made from the three pots on the front panel.**

### Push Button Locator Sound Adjustment Cases:

Case	Condition	Detail	Recommend Adjustment
1	Sound Too Loud Intersection Loud	During a loud or busy traffic time, the Push Button Locator sound can be heard from further than 4 meters (12 feet) away or to the building line.	First try decreasing P (counter clockwise). If this does not lower the sound level, return P to its previous setting and decrease G (counter clockwise) a 1/8 turn then retry decreasing P.
2	Sound Too Quiet Intersection Loud	During a loud or busy traffic time, the Push Button Locator sound cannot be heard from 2 meters (6 feet) away.	Try increasing P (clockwise) until corrected.
3	Sound Too Loud Intersection Quiet	During a quiet or low traffic time, the Push Button Locator sound can be heard from further than 4 meters (12 feet) away or to the building line.	First try decreasing P (counter clockwise). If this does not lower the sound level, return P to its previous setting and decrease G (counter clockwise) a 1/8 turn then retry decreasing P.
4	Sound Too Quiet Intersection Quiet	During a quiet or low traffic time, the Push Button Locator sound cannot be heard from 2 meters (6 feet) away.	Try increasing G (clockwise) until corrected.

Please Note: If the Overhead Beacon Speaker is not used, the Walk and Pedestrian Clearance sound level adjustments will be the same as the Push Button Location sound adjustments. Ignore Step 8. "Testing the Overhead Beacon Sound Level". Otherwise, once the Push Button Level is determined to be adequately adjusted, move to the Step 8. "Testing the Overhead Beacon Sound Level".

## 8. Testing the Overhead Beacon Sound Level

### Normal Operation:

The Overhead Beacon Walk and Pedestrian Clearance sounds should be detectable from approx. two-thirds of the crossing (regardless of ambient sound level). Please note that the sound level will automatically adjust with subtle changes in ambient sound and may not be obvious to the listener. The default settings from the factory are for a standard 4-lane intersection. **These adjustments can be made from the three pots on the front panel.**

### Overhead Beacon Sound Adjustment Cases:

Case	Condition	Detail	Recommend Adjustment
1	Sound Too Loud Intersection Loud	During a loud or busy traffic time, the Overhead Beacon sound can be heard from further than 2/3's of the crossing.	Decrease G (counter clockwise) until corrected.
2	Sound Too Quiet Intersection Loud	During a loud or busy traffic time, the Overhead Beacon sound cannot be heard from 2/3's of the crossing.	Try increasing G (clockwise) until corrected.
3	Sound Too Loud Intersection Quiet	During a quiet or low traffic time, the Overhead Beacon sound can be heard from further than 2/3's of the crossing.	First try decreasing G (counter clockwise). If this does not lower the sound level, return G to its previous setting and decrease B (counter clockwise) a 1/8 turn then retry decreasing G.
4	Sound Too Quiet Intersection Quiet	During a quiet or low traffic time, the Overhead Beacon sound cannot be heard from 2/3's of the crossing.	Try increasing G (clockwise) until corrected.



# DS3000 AUDIBLE PEDESTRIAN SIGNAL INSTALLATION GUIDE

For Technical Support: Tel: 1-866-977-4APS (4277) E-mail: support@novax.com

## 1. Unpacking and Inspection

Package Contains:	(Standard)	(Optional)	
DS3000	PLS000856	Pole Locator Assembly Vibra-Walk1 Vibra-Walk2	PLS000307 PLS000930 MSC000199

Check model No.  
Check serial No.



Check for damage.  
Return if damaged.



## 2. Review Client's Intersection Drawings for the Operational Requirements

Does the client have special instructions for setup of DS3000 APS?

Is the Button Detection feature required? If so, is there a default setting?

Is the Inhibit (Mute) feature to be wired to the traffic controller?

Does this installation require a 24VDC or 120VAC remote sound Inhibit?

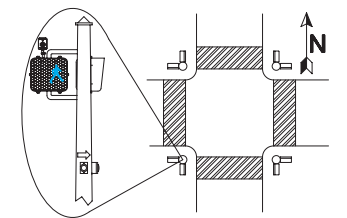

Typical Plans

## 3. Suggested Configuration for Installation of DS3000

### Removal of Face Plate Assembly

Remove Faceplate Assembly with a Phillips Screwdriver

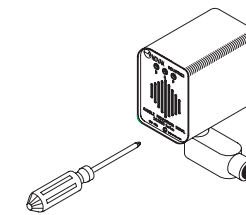

### Inhibit Switch "SW1"

**CAUTION:**  
The Inhibit Function is set at the Factory for 120 VAC. If 24 VDC operation is required then Switch SW1 is set down.

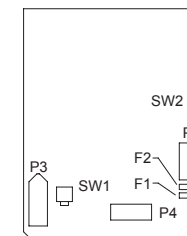

SW1 Down = 24 VDC  
SW1 Up = 120 VAC (Factory Default Setting)

### Installation Method "B"

DS3000 mounts to top of Pedestrian Head via 1/2" conduit clearance hole.

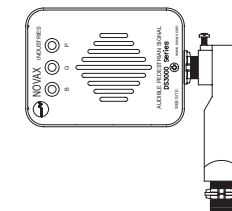

1/2" Locknut is provided.

### Configuration for Installation

See page 2 for details

DSW1 = 8 Position  
DSW2 = 8 Position  
SW1 = Inhibit Switch  
SW2 = Button Power Switch

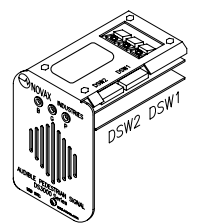

### Installation Method "A"

DS3000 mounts to side of Pedestrian Head or pole via 1/2" conduit clearance or threaded hole.

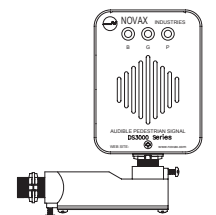

1/2" Locknut is provided.

### Sound Direction Adjustment

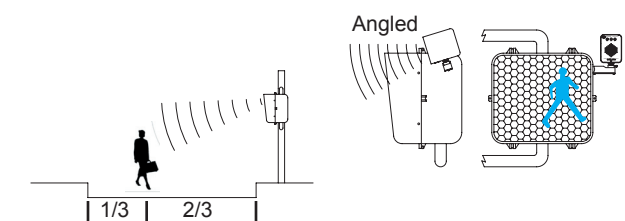

## 4. DS3000 DIP Switch Settings

- 1. Sound Select:**  
Select sound # to play (only one setting should be turned ON), DSW1-1, -2, -3, or -4. (Refer to the sound table provided inside the DS3000). Custom voice messages are always on #1.
  - 2. Sound w/o Button Press**  
Select DSW1-5 ON to play the Walk sound with the Walk signal as if the push button had been pressed.  
Select DSW1-5 OFF. The button must be pressed prior to (or during the Walk signal\*) to play Walk sound with Walk signal  
\* DS3000 Mode only
  - 3. DS100 / DS2000 Legacy Mode:**  
Select DSW1-6 ON to play the Walk & Ped Clear (If programmed) sound at Overhead speaker only (DS100, DS2000 Mode)  
Select DSW1-6 OFF for the default (DS3000 Mode) Auto speaker selection.
  - 4. Play Mode:**  
Select DSW1-7 OFF to have the APS units on either side of the crossing play simultaneously.  
Select DSW1-7 ON to have the APS units on either side of the crossing alternate playing.
  - 5. Play Mode Select:**  
If DSW1-7 is ON, refer to Table 4 for DSW1-8 selection (OFF = ODD, ON = EVEN)
  - 6. Walk Sound Repeat:**  
Select DSW2-1 and -2 per Table 1. Refer to Operation Manual (MAN000094) for details. Default = both switches off.
  - 7. Pedestrian Button Hold Timer (BAT Feature):**  
Select DSW2-3, -4, or -5 or any combination to define the amount of time to depress the push button to request special APS features.\*\* See table 3 for time selection.
  - 8. Max Walk Sound Timer:**  
Select Max Time to play the WALK sound. (Important for very long walk times or intersections with Rest in Walk).  
The Ped. Clearance sound will be played immediately following the Max Walk Time setting. Refer to Table 2 for setting of switches DSW2-6, -7, and -8. For Rest in Walk applications, select DSW1-6 OFF (See note 3)
  - 9. For intersections without button activation the DS3000 has the ability to provide the power to a local button actuating the DS3000 sounds locally. SW2 (default setting is external).**  
**Caution: If SW2 is set to internal and the DS3000 is hooked up to a Ped Isolator, damage may occur to the DS3000.**
- \*\*APS Special Feature (DS3000 Mode Only. See Note 3):**  
- if the push button is depressed less than the set hold time then all sounds are played through the Push Button Speaker only  
- if the push button is depressed more than the set hold time then all sounds will be played through both the Push Button and Overhead Beacon Speaker.

**Table 1: Walk Sound Repeat Selection**

No.2	No.1	
off	off	Auto Repeat Sound
off	ON	Play Message Once
ON	off	Play Message Twice
ON	ON	Play Message Three Times

**Table 2: Max Walk Sound Timer**

No.8	No.7	No.6	Time (sec.)
off	off	off	None
off	off	ON	6
off	ON	off	8
off	ON	ON	10
ON	off	off	12
ON	off	ON	14
ON	ON	off	16
ON	ON	ON	18

See Note 8 for Max Walk Timer Features

**Table 3: BAT Timer**

No.5	No.4	No.3	Time (sec.)
off	off	off	None
off	off	ON	1
off	ON	off	2
off	ON	ON	3
ON	off	off	4
ON	off	ON	5
ON	ON	off	6
ON	ON	ON	7

**Table 4: Alternating Sound Settings**

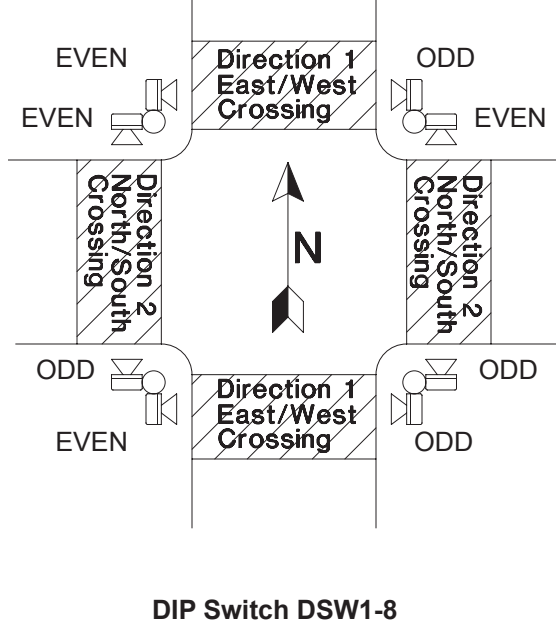

## 5. Electrical Terminations & Functional Layout

Notes: For VibraWalk2 (VB2) wiring see Table A.

Table A

TB	Description / Function
1	Pushbutton (+)
2	Pushbutton (-)
3	Ped Acknowledge LED (+)
4	Ped Acknowledge LED (-)
5	Pushbutton Locator Speaker (+)
6	Pushbutton Locator Speaker (-)
7	Vibrating Arrow (+)
8	Vibrating Arrow (-)

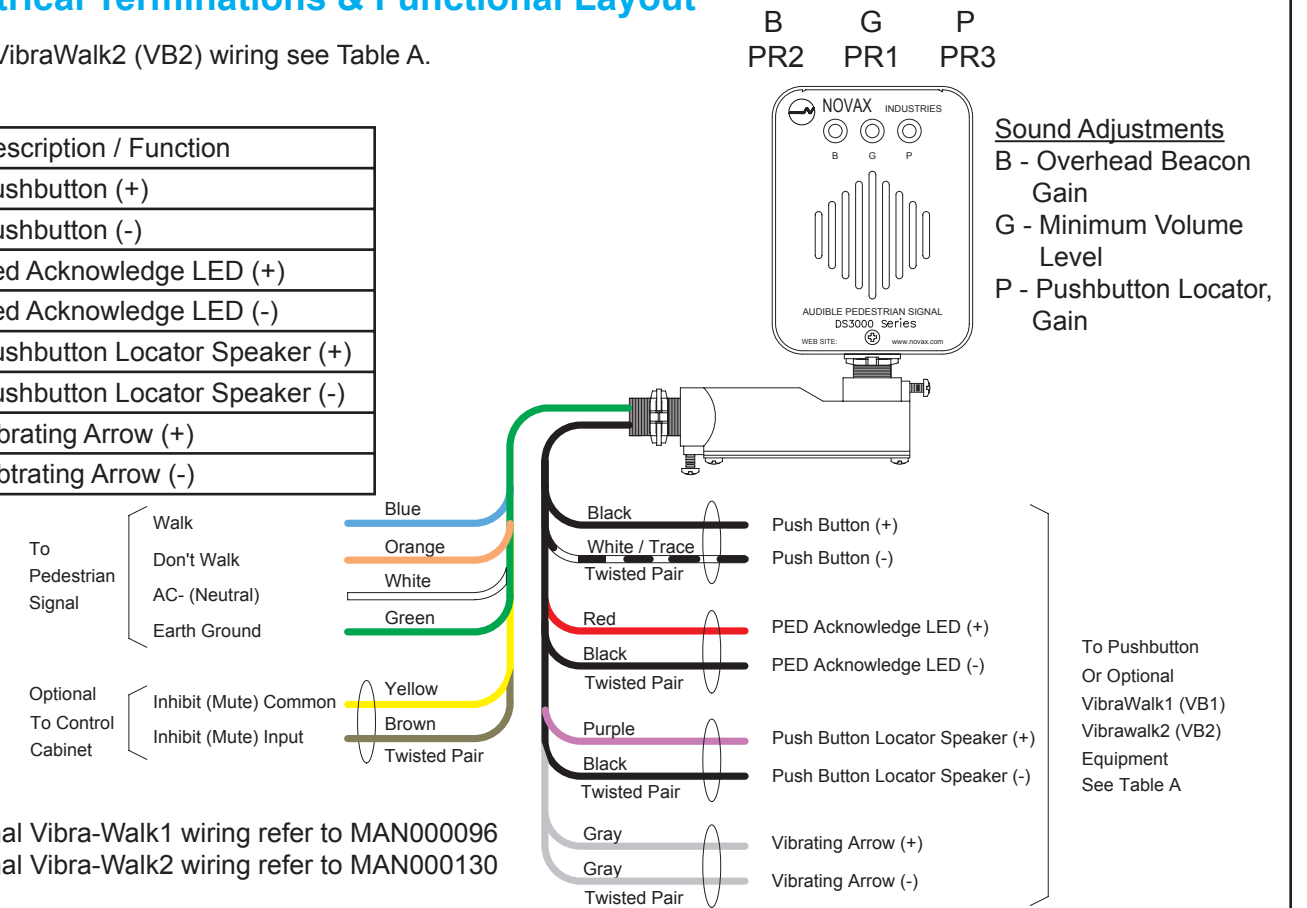

For Optional Vibra-Walk1 wiring refer to MAN000096  
For Optional Vibra-Walk2 wiring refer to MAN000130

## 6. Typical Intersection setup with DS3000 Audible Pedestrian Signal

